

PONo: 11100132420165

Dated: 12.11.2020

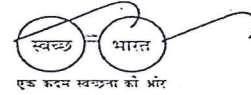

"Under Jurisdiction of Nagpur Court only"

	Western Coalfields Ltd. (A Mini Ratna company) (A Govt. of India Undertaking) (Website :westerncoal.nic.in) e-mail: gmmm.wcl@coalindia.in	 OFFICE OF THE GENERAL MANAGER (MM) FAX . : 0712- 2510284
Regd. Off. : Coal Estate, Civil Lines, Nagpur - 440 001.		

PONo11100132420165

Dated: 12.11.2020

By registered post with A/D

To,
M/s. ROY METAL & ENGINEERING WORKS
VILL-BORTORIA,
PO-MITHANI,
DISTT BURDWAN WEST BENGAL - 713371

Vendor Category: MSE
Vendor Code: 529217

Dear Sir,

Sub:- Supply of Coal Tub Wheel & Axles of Coal Tubs

Ref: 1. Our e-tender ref no WCL/hq-pur-ad-e-43-2020-21 (tender ID 2020_WCL_175084_1)
opened on 17.07.2020

2. Your Bid ID: 532104 Dated 29-Jun-2020.

With reference to the above, we are pleased to place a Formal Supply Order on you for supply of Coal Tub Wheel & Axles as per the Price, quantity, specification, terms and conditions detailed below and as per general terms and conditions enclosed.

SCOPE OF SUPPLY & PRICES:-

Sl no	Item description	Order quantity	Unit price Rs)	Total value (Rs)
1	Wheels & Axles for Mine Tubs as per IS 4001 and confirming to drawing enclosed at annexure I and Technical Specifications enclosed as Annexure-II Brand: Material Code: 93907990028	480 nos	2600.00	1248000.00
	Total			1248000.00
	GST@5%			62400.00
	Total Procurement value			1310400.00

Amount in words: Rupees Thirteen Lakh Ten Thousand Four Hundred Only

Other Terms & Conditions:

1. **Prices:** The prices are FIRM on F.O.R. destination basis inclusive of packing, forwarding, freight and insurance charges upto destination stores.

ds
12/11/20

ds
12/11/20

PONo: 11100132420165

Dated: 12.11.2020

2. **GST:** Shall be payable extra as applicable. The present applicable rate of GST is @ 05%. Input tax credit on GST shall be availed by WCL as per GST rule. Firm shall submit GST compliant invoice enabling WCL to avail Input Tax Credit (ITC) under GST. In case of any failure on suppliers account, the penalty including interest (if any) borne by WCL on ITC shall be recovered from you.

You shall have to comply with the terms and conditions of GST Act/ Rules such as issuance of Tax Invoices, ensure payment of GST and enabling mechanism to facilitate Input Tax credit by WCL.

You shall upload the Tax Invoices/Debit Note/Credit Note in GST Portal, make payment of GST and file returns in time, as prescribed under GST Act and Rule to facilitate WCL to avail Input Tax Credit (ITC) as per eligibility under GST. In case WCL is unable to avail ITC or any liability arises to WCL due to failure on the part of supplier to comply the above provisions, the entire amount including Interest (If any) borne by WCL shall be recovered from supplier

E-way Bill : In the event the delivery of goods by you is on FOR Destination basis, the movement of the goods is to be initiated by the supplier and the supplier is liable to issue e-way bill, as per GST rules

3. **Delivery;** Minimum 40% of the ordered quantity to be supplied within three months from the date of purchase order and balance quantity to be completed within six months from the date of purchase order. Delivery period to be reckoned from the 7th day of order date.

4 **Consignee:** Depot Officer, WCL, Central Store, Tadali Dist: Chandrapur-442406, Maharashtra.

GSTIN : 27AAACW1578L1ZW

5 **PAYING AUTHORITY:** GM (Fin),WCL, HQ ,Coal Estate ,Civil Lines, Nagpur -440001

6. **Payment Terms:** 100% Payment shall be made within 21 days of receipt and acceptance of materials at destination stores or date of submission of bills whichever is later.

Note : Bank account details for EFT as provided by you are given below:

Bank Account Details for making payment through EFT:-

Name of the Account Holder	M/s. ROY METAL & ENGINEERING WORKS
Account Number	358102000000356
Name of the Bank and Branch	IDBI Bank Asansol Branch
Address of the Branch of the Bank	Sree Apartment Burnpur Road Asansol-713304
Nature of Account	Cash Credit
IFSC Code of the Branch	IBKL0000356

dsr
12/11/20

dsr
12/11/20

dsr
12/11/20

7. **Final Inspection** : Final Inspection of the consignment shall be carried out at the destination stores, which will be arranged by the consignee on receipt of stores.

8. **Security Deposit:** i) You are required to submit the Security Deposit for Rs. 131040.00. The Security Deposit shall be in the form of a Bank Demand Draft or in the form of a Bank Guarantee as per format enclosed as Annexure-2 from a RBI Scheduled Bank in India (on a non-judicial stamp paper) within 15 days from date of notification of award or placement of order.

a. The Security Deposit shall be in the same currency in which contract is to be signed / Supply order issued. In case of Multi Currency contract separate SDBG in respective currency for required value as above shall be submitted.

b. In case of equipment, SDBG shall not be individual equipment wise. However, multiple Bank Guarantees for Security Deposit shall be permissible provided value of all the SDBGs totals to 10% of the contract value, and all are submitted simultaneously within the specified time schedule and all of them are in the same prescribed format of SDBG without linking to any particular equipment.

c. The SDBG shall remain valid up to 3 months after completion of supplies and acceptance of materials by the consignee in case of supply of Materials and in case of contracts for equipment involving installation and commissioning, 3 months after the supply and commissioning of all the equipment covered in the contract.

d. Security Deposit will be released within 30 days after completion of supplies and acceptance of material by the consignee in case of supply contract or after successful commissioning and on receipt of confirmation of Performance Bank Guarantee (s) for all the equipment covered in the contract in case of contracts for equipment and all those items/ goods involving installation and commissioning and PBG.

e. Security Deposit may be converted into Performance Bank Guarantee (PBG) wherever PBG is required at the option of the supplier. At the time of conversion of security money into PBG, it should be ensured that the amount of PBG should not be less than 10% of landed value of order. Wherever Security Deposit is converted into PBG, the operation of such SDBG/ Performance BG shall be guided by the Performance Bank Guarantee clause.

g. If the successful tenderer fails to deposit the security deposit within 15 (fifteen) days from date of notification of award/ placement of order, another opportunity shall be given to them for submission of Security Deposit within next 15 days. If the successful tenderer still fails to deposit the security deposit within the extended period but executes the supplies within scheduled delivery period, the submission of Security Deposit shall be waived, as the purpose of submission of SD is fulfilled.

h. If the Supplier fails to deposit the SD within the extended period and no supplies are made, the order shall be cancelled and the case shall be processed to order elsewhere at firm's risk and cost. Moreover, the firm's performance is to be kept recorded for future dealings with them. Further, if during execution of the contract, the firm fails to extend the Bank Guarantee for Security Deposit, suitably as required, the same shall be recorded as unsatisfactory performance for future dealings apart from taking any other penal action as may be deemed fit by WCL.

i. In cases where the successful tenderer did not submit the security deposit even within the extended period for SD submission but has supplied the materials either in full or in part after the extended period for SD submission, the SD shall be deducted from the first bill or in case of insufficient amount from subsequent bill(s) of the supplier till the full SD amount is deducted. Further, a penalty equivalent to 0.5% (half percent) of SD amount for delay of each week or part thereof (period of delay is to be calculated from the 31st day from the date of notification of award/ placement of order to the date of receipt of full SD/deduction of full SD) shall be levied subject to a maximum of 10% of the contract value.

Note: For unsatisfactory performance and / or contractual failure, the security money shall be forfeited.

ii) You will have to submit the Bank Guarantee for Rs. 131040.00 towards the Security deposit. The SDBG shall remain valid up to 3 months after completion of supplies and acceptance of materials by the consignee in case of supply of Materials and in case of supply of equipment involving installation and commissioning, 3 months after the supply and commissioning of all the equipment.

[Handwritten signature]

[Handwritten signature]

[Handwritten signature] 12/11/2020

[Handwritten signature]

PONo: 11100132420165

Dated: 12.11.2020

The Bank Guarantee issued by the issuing bank on behalf of you in the favour of Western Coalfields Ltd shall be in paper form as well as issued under "Structured financial messaging system". The details of beneficiary for issue of BG under SFMS platform is furnished below:

Name of beneficiary and details	
Name	Western Coalfields Ltd
Area	Head Quarter
Bank A/c No: / Cust ID of beneficiary	Current Account no: 005905018053; Customer Id: 556096497 ; ICICI Bank Ltd, Commercial Banking, 9C/A& 9C/B, Ground Floor, Shriram Towers, LIC Square, Nagpur – 440001, Maharashtra
IFSC code	ICIC0000059
Bank Manager Name & Ph no:	UJJWAL KITE: Ph n: 0712-6627389
BG ADVISING MESSAGE – 760COV / 767COV via SFMS	
Field Number	Particulars
7035	ICICI0000059
7037	WCL556096497

The original bank guarantee issued by the issuing bank shall be sent by the issuing bank to the following address by Registered post / Speed Post.

General Manager (MM) I/c
Materials Management Wing
Western Coalfields Ltd HQ, Coal Estate, Civil lines
Nagpur – 440001 Maharashtra

Any extension / amendments to the BG shall be done following the same procedure as above.

For ready reference and updation of BG in WCL portal, it is necessary that BG issuing / amending bank send the BG advise in the form of message format 760COV / 767COV via SFMS (Structured Financial Messaging System) as provided by RBI.

In the event of BG issuing / amending bank not sending the message 760COV / 767COV or committing any error while capturing the details at least in the above mentioned field, BG confirmation through online portal would not be updated if issuing bank does not adhere to advisory, WCL will not be responsible

The above particulars are to be incorporated by the issuing bank properly while issuing BG under SFMS mode to avoid any problem in future.

Original bank Guarantee issued by the Issuing Bank shall be sent by the Issuing Bank to concerned Department/Area by Registered/ Speed Post.

The beneficiary's bank/advising bank shall send a copy of advice received under SFMS mode to concerned Area/HQ through e-mail at their e-mail id and provide print out of the said message from advising bank with seal and signature, to the Finance Dept, of concerned Area/HQ. For this purpose, each Area/HQ shall provide their e-mail ID to the Advising/Beneficiary Bank.

On receipt of the original Bank Guarantee from the Issuing Bank, the concerned department of HQ shall verify the validity/amount of BG and further approach their Associate Finance Department for an advice of BG confirmation received under SFMS mode.

Associate Finance department of the HQ shall forward the advice received under SFMS mode from Advising bank to the concerned department of Area/HQ at their e-mail ID and also hand over the print out of the advice with sign and seal of the Advising Bank. The BG advice received under SFMS mode may be forwarded by Associate Finance department to concerned department suo-moto along with print out of the advice with sign and seal of the Advising Bank, if the details of concerned Area/ department is known.

For this purpose, the concerned department may provide their e-mail ID to their Finance department

On receipt of Original BG in paper form, the concerned department shall verify the same and if found in order, forward the same along with the confirmation message to their HOD(Fin) /Associate Finance for safe custody.

Concerned HOD(Fin)/Associate Finance of the HQs shall pass on the BG along with the confirmation message so forwarded by the concerned department (after acceptance) to their Associate Finance section for safe custody.

Under SFMS, extension/subsequent amendments to the BG can be done following the same procedure as stated above.

For encashment, the BG shall be placed directly before the issuing bank at Nagpur Branch.

[Signature]
12/11/20

[Signature]
12/11

[Signature]
12/11/20

9 **GUARANTEE/WARRANTY** : You will stand composite guarantee / warrantee for satisfactory performance of the Coal Tub Wheels & Axles for a period of 12 months from the date of fitment/commissioning or 18 months from the date of receipt of material at consignee's premises whichever is earlier. In case of warranty claim, the you shall without charge, repair or rectify defective goods or to replace such goods with similar goods free from defect. Any goods repaired or replaced by you shall be delivered at the buyers premises without costs to WCL

10 **Fitment Guarantee**: As per dimensions of the technical specifications indicated at Annexure-II along with dimensions mentioned in the drawing at annexure I

11 **Identification marks**: The manufacturer should mark their identification marks or Logo on non wearable surface of the product.(As per Section-1.b under technical specifications)

12. **SUBMISSION OF BILLS**:- For claiming payment, following documents are to be submitted along with original bills as per terms of the supply order to the consignee.

- i). Pre-receipted and stamped Invoice (as per GST laws).
- ii). Packing list in original list giving details of bill of materials, if applicable. (Invoice should be strictly as per GST laws 2017)
- iii). Consignment note / RR/ LR in original, if applicable.
- iv). E way Bill (As per GST rules)
- v). Warranty / Guarantee certificate,
- vi). Manufacturers test certificate, if applicable. As per technical specification
- vii). Self Attested Work test certificate for materials of Wheels and Axles shall be submitted along with each consignment.
- viii) Price certificate and Price Fall certificate
- ix). Any other document as specified in the Order / specification

13.**LIQUIDATED DAMAGES**:- : In the event of failure to deliver or dispatch the equipment/ stores within the stipulated date/period in accordance with the terms and conditions and the specifications mentioned in the supply order and in the event of breach of any of the terms and conditions mentioned in the supply order, the Purchaser shall have the right:

- (a) To recover from the successful bidder as agreed liquidated damages, a sum not less than 0.5% (Half Percent) of the price of any equipment/ stores which the successful tenderer has not been able to supply as aforesaid for each week or part of a week during which the delivery of such stores may be in arrears limited to 10% (Ten Percent) of the total contract value, or
- (b) To purchase elsewhere after due notice to the successful tenderer on the account and at the risk of the defaulting supplier, the equipment/stores not supplied or others of similar description without cancelling the supply order in respect of the consignment not yet due for supply, or
- (c) To cancel the supply order or a portion thereof, and if so desired to purchase the equipment/ stores at the risk and cost of the defaulting supplier and also,
- (d) To extend the period of delivery with or without penalty as may be considered fit and proper. The penalty, if imposed, shall not be more than the agreed liquidated damages referred to in clause (a) above.
- (e) To forfeit the security deposit full or in part.
- (f) Whenever under this contract any sum of money is recoverable from and payable by the supplier, the Purchaser shall be entitled to recover such sum by appropriating in part or in whole by deducting any sum or which at any time thereafter may become due to the successful tenderer in this or any other contract. Should this sum be not sufficient to recover the full amount

PONo: 11100132420165

Dated: 12.11.2020

recoverable, the successful tenderer shall pay the Purchaser on demand the remaining balance. The supplier shall not be entitled to any gain on any such purchase.

For the purpose of the calculation of the liquidated damages amount, the basic Free Delivery at Site price shall be considered Taxes and duties shall not be taken into account for calculation of LD. However, when prices indicated in the order are inclusive of taxes and duties, such prices will be taken for calculation of LD.

Denial Clause:

In case of extension of delivery period, any increase in statutory duties and/or upward rise in prices due to price variation clause and/or exchange rate variation clause, is to be borne by the seller during the extended delivery period, while purchaser reserves its right to get any benefit of downward revisions in statutory duties, PVC and exchange rate variation clause

14. FORCE MAJEURE CLAUSE:- a) If at any time, during the continuance of this contract, the performance in whole or in part by either party of any obligation under this contract shall be prevented or delayed by reason of any wars or revolutions, hostility, acts of public enemy, civil commotion, sabotage, fires, floods, explosions, epidemics, quarantine restrictions, strikes, lockouts, freight embargoes or act of God (hereinafter referred to "events") provided, notice of the happening of any such event is given by either party to the other within 21 days from the date of occurrence thereof neither party shall by reason of such event, be entitled to terminate this contract nor shall either party have any claim for damages against the other in respect of such non-performance or delay in performance, and deliveries under the contract shall be resumed as soon as practicable after such event has come to an end or ceased to exist, provide further that if the performance in whole or part or any obligation under this contract is prevented or delayed by reason of any such event for a period exceeding 60 days, either party may at its option terminate the contract provided also that if the contract is terminated under this clause, the purchaser shall be at liberty to take over from the contractor at a price to be fixed by the CIL / Subsidiary Company, which shall be final, all unused, un damaged and acceptable materials, bought out components and stores in course of manufacture in the possession of the contractor at the time of such termination or such portion thereof as the purchaser may deem fit excepting such materials, bought out components and stores as the contractor may with the concurrence of the purchaser elect to retain."

b) If there is delay in performance or other failures by the supplier to perform its obligation under the contract due to an event of a Force Majeure and the contract is governed by Force Majeure Clause, the supplier shall not be held responsible for such delays/failures. In such a situation, the supplier shall promptly notify the purchaser in writing of such conditions and the cause thereof, duly certified by the local Chamber of Commerce or Statutory authorities, the beginning and end of the causes of the delay, within twenty one days of occurrence and cessation of such Force Majeure Conditions. Unless otherwise directed by the purchaser in writing, the supplier shall continue to perform its obligations reasonable alternative means for performance not prevented by the Force Majeure event.

c) For delays arising out of Force Majeure, the supplier will not claim extension in completion date for a period exceeding the period of delay attributable to the causes of Force Majeure.

15. PACKING:- The packing of all the materials quoted shall conform to the requirements of the carriers.

de
12/11/20

12/11/2020

16 Price Fall Clause : "The Bidder undertakes that it has not offered to supply / supplied / is not supplying same or similar product / systems or sub systems at a price lower than that offered in the present bid in respect of any Organization / Ministry / Department of the Govt, of India or Coal India Ltd. and /or its Subsidiaries or other P S U or any other private organization during the currency of the contract and if it is found at any stage that same or similar product / systems or sub systems was supplied by the bidder to any Organization / Ministry / Department of the Govt, of India or Coal India Ltd. and /or its Subsidiaries or other PSU or any other private organization at a lower price during the currency of the contract, then that very price will be applicable to the present case and the difference in the cost would be refunded by the bidder to buyer, if the contract has already been concluded .

- (i) The currency of contract will mean the period till completion of supply.
(ii). It shall be responsibility of the supplier to inform the purchaser of offer to supply / supply of the similar /ordered item (s) at a lower rate to any Organization / Ministry / Department of the Govt, of India or Coal India Ltd. and /or its Subsidiaries or other PSU or any other private organization during the currency of the contract.
(iv) The supplier shall submit a certificate along with the bill(s) that it has not offered to supply / supplied the similar /ordered item (s) at a lower rate to any Organization / Ministry / Department of the Govt, of India or Coal India Ltd. and /or its Subsidiaries or other PSU or any other private organization. "

17. Price Certificate: A Price Certificate shall be submitted along with the invoice / on the body of the invoice as under: "*Certified that we have not offered the same products at a price lower than that offered in the present bid in respect of any other ministry/ department of the Govt. of India or a PSU. In case we offer the lower prices for same items under similar terms within the validity of this offer to ministry/department of the Govt. of India or a PSU, we undertake to notify such reduction to the buyer and the same will also be applicable against this offer.*"

18. Risk Purchase In the event of failure of the supplier to deliver or dispatch the stores within the stipulated date/period of the supply order or in the event of breach of any of the terms and conditions mentioned in the supply order/ contract, WCL shall have the right to purchase the stores from elsewhere after due notice to the defaulting supplier at the risk and cost of the defaulting supplier. The cost as per risk purchase exercise shall be recovered from the Earnest Money Deposit/ Security Deposit/ Performance Security of the supplier and/or bills submitted by the supplier against the same contract or any other contract pending in the same Subsidiary Co. and/or in any other Subsidiary Companies / CIL.

Risk Purchase Action shall be initiated as a last resort, if the supplier has failed to deliver despite having been given adequate and proper notice to discharge its obligations and under any of the following conditions:

- a) When the supplier fails to deliver the materials even after extending the delivery period. b) When the supplier fails to respond to purchaser's request for supply of the materials and fails to provide any genuine and bonafide reason for the delay in supply.
c) When the supplier breaches any of the terms and conditions of the supply order/ contract and as a result fails to execute the order satisfactorily.

19. GENERAL CONDITIONS Of the Contract : Unless otherwise specified in the order, the order shall be subject to General conditions of the contract as per Annexure-II

This order is being placed on the basis of the terms and conditions already accepted by you.

Two copies of this supply order are being sent to you. You may acknowledge receipt of the order by sending one copy duly signed and stamped with seal of your company.

Handwritten signature and date: 12/11/2020

Handwritten signature and date: 12/11/2020

PONo: 11100132420165

Dated: 12.11.2020

All other terms and condition shall be as per NIT.

Encl:-

- 1 Dimensional Drawing for Wheel & Axles of Mine Coal Tub- Annexure I
- 2.Detailed Specification. Annexure - ' II'
- 3.General Conditions of the contract of the supply order Annexure - ' III '.
- 4.Bank Guarantee for Security Deposit - Annexure - ' IV '
5. Budget Certification and Allocation against MB 2020-21(for internal use of WCL). Annexure - ' V '

Yours Faithfully,
For & on behalf of Western Coalfields Ltd.



(S S Bhal)
Chief Manager(MM)
COPY TO:

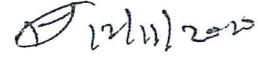

(K S R Divakar)
Chief Manager (MM)

- 1.GM(E&M)/HOD, WCL, HQ, Nagpur.
- 2.GM(Fin)/c, WCL, HQ, Nagpur
3. Chief Mnager(Fin)/Sr. Manager (Finance)/C&B, WCL , HQ, Nagpur.
4. Chief. Manager (F) (MM.), WCL, HQ, Nagpur – This is with reference to his concurrence No 109/30 /2020-21, Dated. 01.10.2020
- 5.AGM/ASO/SO(MM)/AFM, All Areas of WCL
- 6:Depot Officer, WCL, Central Store, Tadali, Dist: Chandrapur-442406, Maharashtra.
7. GM(MM)/HOD: BCCL/CCL/ECL/SECL/MCL/NCL/CIL

This Refers e-Office File No 258351.

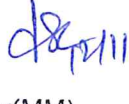
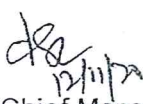

Chief Manager(MM)

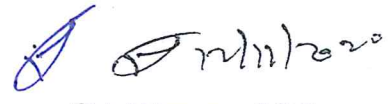

Chief Manager (MM)

WHEEL AND AXLE FOR COAL TUB
ALL DIMENSIONS ARE IN mm

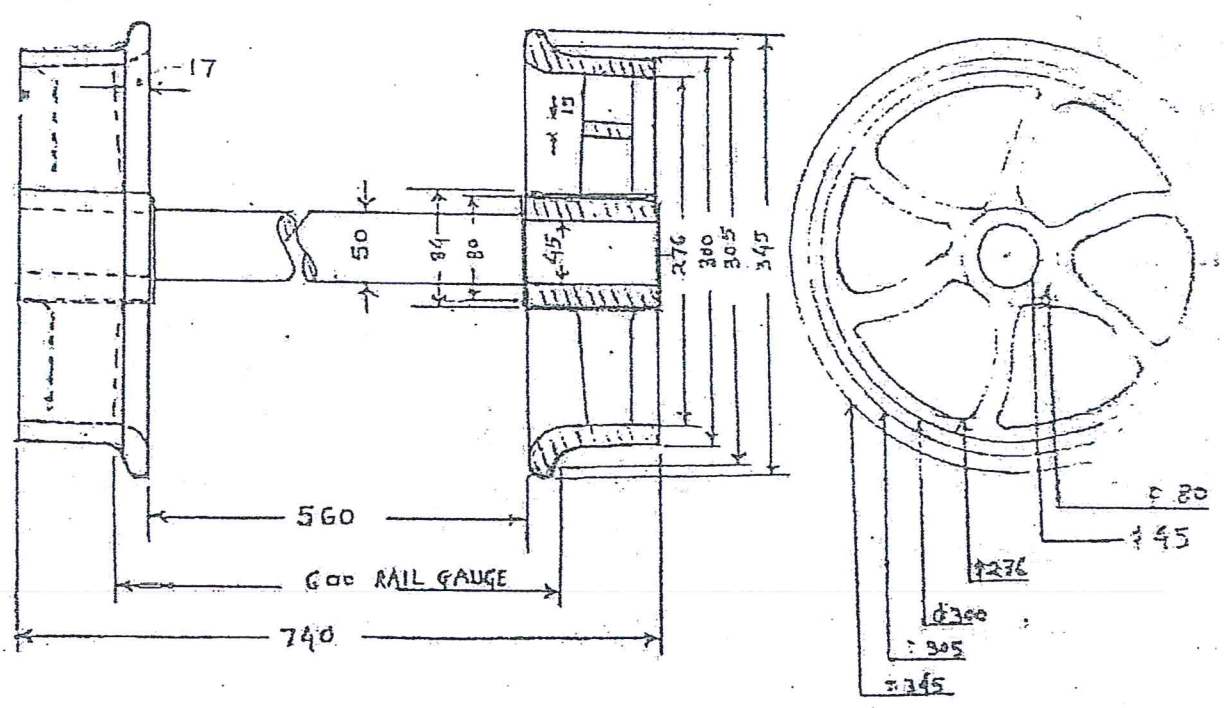

db
12/1/20

db
12/1/20

12/1/2020



ANNEXURE-II

Detailed Technical Specification:

Sl No	Standard & Marking	
1.a	The specification shall conform to	IS :4001
1.b	Marking:-Each wheel shall have cast in the back of flange, the following information in recessed projected characters not less than 10 mm high : 1. Manufacturer identification mark, 2. The letter PM to indicate 1.5% manganese steel	
1.c	Technical Parameters	
1.d	Dimension of Wheels and Axles	As per drawing enclosed as Annexure-I
1.e	Material of Wheels	Grade 3 of IS : 2708
1.f	Material of Axle	Class 4 of IS : 1875
1.g	Heat Treatment	As per clause no. 6.1.1 of IS : 4001
1.h	Weight of Wheel (Two)	(17.5 kg each) 35 Kg
1.i	Minimum Weight of Axle	10 kg
1.j	Total Weight(minimum) of Wheel and Axle	45 kg
Note :-Self Attested Work test certificate for materials of Wheels and Axles shall be submitted along with each consignment.		

12/11/20

12/11/20

 12/11/2020

ANNEXURE - III

General Conditions of Contract (GCC)

1. Definitions

In the interpretation of the contract and the general and special conditions governing it, unless the context otherwise requires, the following terms shall be interpreted as indicated below:

- a) "The Contract" means the agreement entered into between the Purchaser and the Supplier including all attachments and appendices thereto and all documents incorporated by reference therein including Invitation to tender, Instructions to tenders, Acceptance of tender, Particulars and the General and Special Conditions specified in the acceptance of tender;
- b) "Contract Price" means the price payable to the Supplier under the Contract for the full and proper performance of its contractual obligations;
- c) "Goods" means all of the equipment, plant, machinery, and/or other materials which the Supplier is required to supply to the Purchaser under the Contract;
- d) "Services" means those Services ancillary to the supply of the Goods, such as transportation and insurance, and any other incidental Services, such as installation, commissioning, provision of technical assistance, training and other such obligations of the Supplier covered under the Contract;
- e) "GCC" means the Conditions of Contract contained in this section;
- f) "SCC" means the Special Conditions of Contract;
- g) "Purchaser" means the organization purchasing goods and services, i.e., Coal India Limited or its subsidiaries or areas falling under various subsidiaries of Coal India Limited;
- h) "Purchaser's country" is India;
- i) "Supplier/Contractor" means the individual, firm or company with whom the contract has been concluded for supplying the Goods and Services under the Contract. The Supplier/Contractor shall be deemed to include its successors (approved by the purchaser), representatives, heirs, executors, administrators and permitted;
- j) "CIL" means Coal India Limited or the Subsidiary Company of CIL or areas falling under various subsidiaries of CIL where Goods are deployed/ used;
- k) "Year" means the Calendar Year.
- l) "Chairman" means the Chairman of Coal India Limited.
- m) "Chairman-cum-Managing Director" means Chairman-cum-Managing Director of any of the Subsidiary Companies of Coal India Limited, presently Central Coalfields Limited, Eastern Coalfields Limited, Western Coalfields Limited, Bharat Coking Coal Limited, Central Mine Planning & Design Institute Limited, South Eastern Coalfields Limited, Northern Coalfields Limited and Mahanadi Coalfields Limited.
- n) "Drawing" means the drawing and plans specified in or annexed to the schedule or specifications.
- o) "Inspector" means any person nominated by or on behalf of the purchaser to inspect supplies, stores or work under the contract or his duly authorized agent.
- p) "Progress Officer" means any person nominated by or on behalf of the Purchaser to visit supplier's works to ascertain position of deliveries of Goods ordered.
- q) "Materials" shall mean anything used in the manufacture or fabrication of the stores.
- r) "Stores" means the goods specified in the Supply Order or schedule which the supplier/contractor has agreed to supply under contract.
- s) "Test" means such test or tests as are prescribed by the specifications or considered necessary by the Inspector or any agency acting under direction of the Inspector.
- t) "Site" mean the place or places named in the "Supply Order" or such other place or places at which any work has to be carried out as may be approved by the purchaser.
- u) Words denoting the persons shall include any company or association or body of individuals whether incorporated or not.
- v) Words in singular include the plural and vice-versa.
- w) Words denoting the masculine gender shall be taken to include the feminine gender.
- x) "Writing" shall include any manuscript, typewritten or printed statement under or over signature or seal as the case may be.
- y) "Unit" and "Quantity" means the unit and quantity specified in the schedule.
- z) "Purchase Order" or "Supply Order" or "Order" or "Contract" means an order for supply of stores and includes an order for performance. The terms "Supply Order", "Purchase Order", "Order" and "Contract" are interchangeable.
- aa) "Particulars" shall mean the following:
- i) Specifications;
 - ii) Drawing;
 - iii) Sealed pattern denoting a pattern sealed and signed by the Inspector;
 - iv) Certified or sealed sample denoting a copy of the sealed pattern or sample sealed by the purchaser for guidance of the Inspector;
 - v) Trade pattern denoting a standard of the ISI or other standardising authority or Coal India Ltd. and/ or any of its subsidiary companies or a general standard of the industry and obtainable in the open market;
 - vi) Proprietary make denoting the product of an individual manufacturer;
 - vii) Any other details governing the construction, manufacture and/or supply as existing in the contract.
- bb) Terms and expressions not defined herein shall have the meanings assigned to them in the Indian Sale of Goods Act, 1930 or the Indian Contract, 1872 or the General Clauses Act, 1897, as amended, as the case may be.

2. Application

These Conditions shall apply to the extent that they are not superseded by provisions in other parts of the Contract.

3. Standards

The Goods supplied under this Contract shall conform to the standards mentioned in the Technical Specifications. Such standards shall be the latest issued by the concerned institution.

4. Use of Contract Documents and Information

4.1. The Supplier shall not, without the Purchaser's prior written consent, disclose the Contract, or any provision thereof, or any specification, plan, drawing, pattern, sample or information furnished by or on behalf of the Purchaser in connection therewith, to any person other than a person employed by the Supplier in the performance of the Contract. Disclosure to any such employed person shall be made in confidence and shall extend only so far as may be necessary for purposes of such performance.

4.2. The Supplier shall not, without the Purchaser's prior written consent, make use of any document or information enumerated in sub-clause 4.1 above, except for purposes of performing the Contract.

4.3. Any document, other than the Contract itself, enumerated in sub-clause 4.1 above shall remain the property of the Purchaser and shall be returned (in all copies) to the Purchaser on completion of the Supplier's performance under the Contract if so required by the Purchaser.

5. Patent Rights

The Supplier shall indemnify the Purchaser against all third-party claims of infringement of patent, trademark or industrial design rights arising from use of the Goods or any part thereof in the Purchaser's country.

6. Security Deposit

6.1. The successful tenderers will have to submit Security Deposit for the 10% value of the total landed value of the contract including all taxes, duties and other costs and charges, without considering Input Tax Credit.

6.2. The Security Deposit shall be in the form of a Bank Demand Draft or in the form of a Bank Guarantee in the prescribed format from a RBI Scheduled Bank in purchaser's country (on a non-judicial stamp paper) within 15 days from date of notification of award or placement of order.

6.3. The Security Deposit shall be in the same currency(ies) in which contract is to be signed/ issued. In case of multi-currency contract, separate Security Deposit Bank Guarantee (SDBG) in respective currency for required value as above shall be submitted.

6.4. In case of equipment, SDBG shall not be individual equipment wise. However, multiple Bank Guarantees for Security Deposit shall be permissible provided value of all the SDBGs totals to 10% of the contract value, and all are submitted simultaneously within the specified time schedule and all of them are in the same prescribed format of SDBG without linking to any particular equipment.

6.5. The SDBG shall remain valid up to 3 months after completion of supplies and acceptance of materials by the consignee in case of supply contracts and in case of contracts for equipment involving installation and commissioning, 3 months after the supply and commissioning of all the equipment covered in the contract.

6.6. If the successful tenderer fails to deposit the security deposit within 15 (fifteen) days from date of notification of award/ placement of order, another opportunity may be given to them for submission of Security Deposit within next 15 days. If the successful tenderer still fails to deposit the security deposit within the extended period but executes the supplies within scheduled delivery period, the submission of Security Deposit may be waived, as the purpose of submission of SD is fulfilled.

If the Supplier fails to deposit the SD within the extended period and no supplies are made, the order shall be cancelled and the case shall be processed to order elsewhere at firm's risk and cost. Moreover, the firm's performance is to be kept recorded for future dealings with them. Further, if during execution of the contract, the firm fails to extend the Bank Guarantee for Security Deposit, suitably as required, the same shall be recorded as unsatisfactory performance for future dealings apart from taking any other penal action as may be deemed fit by CIL.

6.7. In cases where the successful tenderer did not submit the security deposit even within the extended period for SD submission but has supplied the materials either in full or in part after the extended period for SD submission, the SD may be deducted from the first bill or in case of insufficient amount from subsequent bill(s) of the supplier till the full SD amount is deducted. Further, a penalty equivalent to 0.5% (half percent) of SD amount for delay of each week or part thereof (period of delay is to be calculated from the 31st day from the date of notification of award/ placement of order to the date of receipt of full SD/ deduction of full SD) shall be levied subject to a maximum of 10% of the contract value.

6.8. Security Deposit will be released with the approval of HOD of MM Department/ Area GM within 30 days after completion of supplies and acceptance of material by the consignee in case of supply contractor after successful commissioning and on receipt of confirmation of Performance Bank Guarantee(s) for all the equipment covered in the contract in case of contracts for equipment and all those items/ goods involving installation and commissioning and PBG.

6.9. Security Deposit may be converted into Performance Bank Guarantee (PBG) wherever PBG is required at the option of the supplier. At the time of conversion of security money into PBG, it should be ensured that the amount of PBG should not be less than 10% of landed value of order. Wherever Security Deposit is converted into PBG, the operation of such SDBG/ Performance BG shall be guided by Performance Bank Guarantee Clause.

6.10. All Central/State Government Organization/PSUs shall be exempted from submission of Security Deposit. OEM/OES shall also be exempted from submission of Security Deposit in case of procurement of Spare Parts for equipment against Single Tender Enquiry/Open/Limited Tenders.

6.11. Submission of Security Deposit is exempted for the contracts having value upto Rs.2 lakhs.

6.12. The SDBG will be submitted Through Structured Financial Management System (SFMS).

7. Performance Bank Guarantee

7.1. Wherever applicable, the successful bidder shall be required to furnish a Performance Guarantee equivalent to 10% value of the total landed value of the contract including all taxes, duties and other costs and charges, without considering Input Tax Credit.

7.2. The Performance Guarantee shall be in the form of a Bank Guarantee issued by a RBI scheduled bank in India in the prescribed format on a non-judicial stamp paper.

7.3. The Performance Bank Guarantee (PBG) shall be in the same currency (ies) in which contract has been signed. In case of multi-currency contract, separate PBG in respective currency for required value shall be submitted.



7.4. If the contract is for procurement of equipment, the PBG (s) may be submitted equipment wise also. For this purpose, the value of each equipment will be worked out by dividing the total value of contract for a particular item of NIT, worked out as per provisions contained in clause-7 above, by the number of equipment ordered for that particular item of the NIT.

7.5. The PBG (s) shall remain valid till 3 months after the completion of warranty period.

7.6. The PBG shall be submitted sufficiently in advance (say 3-4 weeks) to enable its verification from the issuing bank, before submission of the invoice for 80% payment of the particular goods/ equipment(s).

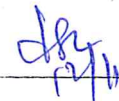
7.7. The release of the Performance Bank guarantee(s) after above indicated period, shall be subject to satisfactory performance of the equipment/ items during the warranty period and fulfillment of contractual obligations failing which, action for further

 12/11/2020

extension or encashment of PBG, as deemed suitable shall be taken. The Performance Bank Guarantee shall be released after expiry of validity period if no claim is pending, with the approval of the concerned HOD (MM)/ Area GM.

7.8. In case of procurement of equipment, if the successful tenderer which does not have the After Sales Service Support facilities in India like Depot/ Warehouse for supply of spare parts, Workshop facilities for servicing and repair of assemblies, sub-assemblies and equipment, availability of trained technical manpower etc., training facilities for providing training to CIL's personnel, wherever required, additional Performance Bank Guarantee for the 30% value of the total landed value of the contract including all taxes, duties and other costs and charges shall have to be submitted. This 30% PBG will be released after establishment of After Sales Service Support facilities in India subject to confirmation of the same by concerned Head of Technical Department. However, the supplier shall have to submit PBG for 10% of the total contract value to be kept valid for the remaining period of the contract plus 3 months processing period before release of 30% PBG. This 10% PBG will be released after satisfactory performance of all equipment/ items and fulfillment of contractual obligations including warranty obligations.

7.9. The PBG will be submitted through Structured Financial Management System (SFMS).

8. Inspections and Tests

8.1. The Purchaser or its representative shall have the right to inspect and/or to test the Goods to confirm their conformity to the Contract Specifications at no extra cost to the Purchaser. Generally, the Goods shall be of the best quality and workmanship and comply with the contract or supply order in all respect. The Technical Specifications shall specify what inspections and tests the Purchaser requires and where they are to be conducted. The Purchaser shall notify the Supplier in writing, of the identity of the inspectors). The Purchaser reserves the right, at the Purchaser's cost, to depute its own inspectors) and/or to engage any other third party inspecting agency, to conduct inspections and tests pursuant to the Contract. Sufficient time, atleast 30 days in advance will be given for inspection.

8.2. The inspections and tests may be conducted on the premises of the Supplier, at point of delivery and/or at the Goods' final destination. If conducted on the premises of the Supplier, all reasonable facilities and assistance, including access to drawings and production data, shall be furnished to the inspectors at no charge to the Purchaser. However, any drawing and proprietary information provided for this purpose shall remain in control of the supplier. The inspector shall have full and free access at the supplier's works for the purpose of carrying out inspection. The Inspector shall have the right to put all the stores or materials forming part of the same or any part thereof to such tests as he may think fit and proper. The supplier shall not be entitled to object, on any ground whatsoever, to the method of testing adopted by the Inspector. Unless otherwise provided for in the contract, all stores/materials expended in test will be to supplier's account. In the event of Goods found acceptable by the Inspector during inspection, he shall furnish the supplier with necessary copies of Inspection notes for attaching to the supplier's bill.

8.3. Should any inspected or tested Goods fail to conform to the Specifications, including acceptance tests and periodic tests to verify guaranteed performance, the Purchaser may reject the Goods, and the Supplier shall either replace the rejected Goods or make alterations necessary to meet Specification requirements free of cost to the Purchaser within thirty days of such rejection. Replaced or altered goods shall be subjected to repeated inspection or tests to demonstrate conformity with the Specifications. In the event that replacement or alteration is not done within thirty day period as aforesaid, or, replaced or altered goods fail to demonstrate conformity with the Specifications in repeated inspections or tests as aforesaid, the Purchaser reserves the right to terminate the Contract in part or in whole and the Supplier shall repay forthwith to the Purchaser all monies paid including all costs incurred in the inspection and tests, in respect of Goods and Services associated therewith, for which the termination is applicable and, subsequently remove the same from the Purchaser's Site at the Supplier's cost.

8.4. Any Goods rejected at a place other than the premises of the supplier, shall be removed by the supplier within 14 days of the date of receipt of intimation of such rejection. The Inspector may call upon the supplier to remove what he considers to be dangerous, infected or perishable Goods, within 48 hours of the receipt of such intimation. The rejected stores shall under all circumstances lie at the risk of the supplier from the moment of rejection and if such stores are not removed by the supplier within the above mentioned period, the Inspector/Purchaser may either return the same to the supplier at the supplier's risk and cost (a public tariff rate) by such mode of transport as the Purchaser or Inspector may select or dispose of such stores at the supplier's risk on his account and retain in such portion of the proceeds as may be necessary to cover any expense incurred in connection with such disposal. The purchaser shall also be entitled to recover handling and storage charges for the period during which the rejected stores are not removed.

8.5. The Purchaser's right to inspect, test and where necessary, reject the Goods after the Goods' arrival in the Purchaser's country shall in no way be limited or waived by reason of the Goods having previously been inspected, tested and passed by the Purchaser or its representative prior to the Goods' shipment from the Supplier's premises.

8.6. Nothing in this clause shall in any way relieve the Supplier of any warranty or other obligations under this Contract.

9. Packing and Marking

9.1. The Supplier shall provide such packing of the Goods as is required to prevent their damage or deterioration during transit to their final destination, as indicated in the Contract. The packing shall be sufficient to withstand, without limitation, rough handling during transit and exposure to extreme temperatures, salt and precipitation during transit and open storage. Packing case size and weights shall take into consideration, where appropriate, the remoteness of the Goods' final destination and the absence of heavy handling facilities at all points in transit.

9.2. All packing cases, containers, packing and other similar materials shall be supplied free by the Supplier and these shall not be returned unless otherwise specified in the Contract/Purchase order.

9.3. The packing, marking and documentation within and outside the packages shall comply strictly with such special requirements as shall be expressly provided for in the Contract, including additional requirements, if any, specified in the contract and in any subsequent instructions ordered by the Purchaser. Packages will be stamped with identification marks both outside the packages as well as on the contents inside. Packages containing articles liable to be broken by rough handling like glass or machinery made of cast iron will be marked with cautionary works like 'Fragile' 'Handle with care'.

9.4. The marking of the Goods must comply with the requirements of the law relating to Merchandise Mark, in force in India.

9.5. Packing instructions: The Supplier will be required to make separate packages for each consignee. Each package will be marked on three sides with proper paint with the following:

- i. Project;
- ii. Contract No;
- iii. Country of origin of Goods;
- iv. Supplier's name;
- v. Packing list Reference Number;
- vi. The gross weight, net weight and cubic measurement;
- vii. Consignee Name and Address;

DR
MM

DR
MM

[Signature]
12/11/2020

9.6. A complete list of contents in each package called the packing list will be prepared and one copy of the packing list shall be inserted inside the package.

10. Delivery and Documents

10.1. The delivery period stipulated in the Contract/Purchase Order shall be deemed to be the essence of the contract and delivery of the Goods must be completed within the specified period.

10.2. Delivery of the Goods shall be made by the Supplier in accordance with the terms specified in the Schedule of Requirements. The delivery of Goods shall be deemed to take place on delivery of the Goods in accordance with the terms of the contract after approval of Goods by the Inspector.

10.3. For purposes of the Contract, "EXW", "FOB", "FCA", "CFR", "CIF", "CIP" and other trade terms used to describe the obligations of the Parties shall have the meanings assigned to them by the prevailing edition of *Incoterms* on the date of tender opening, published by the International Chamber of Commerce, Paris.

10.4. The details of shipping documents to be furnished by the Supplier are specified below:

(a) For Imported Goods:

Within forty eight (48) hours of shipment, the Supplier shall notify the Purchaser, Port Consignee and Ultimate Consignee by fax and email, full details of the shipment including Contract number, description of Goods, quantity, the vessel, the bill of lading number and date, port of loading, date of shipment, port of discharge, etc. The Supplier shall deliver by express courier service the following documents to the Purchaser, with a copy to the Port Consignee and Ultimate Consignee:

i. Supplier's shipping invoice showing Contract Number, Goods description, quantity, unit price, total amount and GST number of ultimate consignee;

ii. Clean on-board bill of lading indicating the Importer-Exporter Code (IEC) of the concerned Subsidiary Company of CIL and non-negotiable bill of lading;

iii. Packing list identifying contents of each package;

iv. Manufacturer's/Supplier's warranty /guarantee certificate;

v. Manufacturer's Test & Inspection certificate;

vi. Certificate of Country of Origin issued by the Chamber of Commerce of Manufacturer's Country;

vii. Documentary evidence of marine freight & marine insurance

The above documents shall be sent by supplier well in advance, so that the same are received by the Purchaser at least one (1) week before arrival of the Goods at the port or place of arrival and, if not received, the Supplier will be responsible for any consequent expenses.

(b) For Domestic Goods from within India:

Upon dispatch of the Goods to the consignee, the Supplier shall notify the Purchaser and Ultimate Consignee and deliver by express courier service the following documents to the Purchaser with a copy to the Ultimate Consignee:

i. Supplier's invoice showing Contract Number, Goods description, quantity, unit price, total amount;

ii. Railway receipt/ Transporter's consignment note /acknowledgement of receipt of Goods from the consignee(s);

iii. Manufacturer's/Supplier's warranty / guarantee certificate;

iv. Manufacturer's Test & Inspection certificate;

The above documents shall be provided by the supplier at the time of arrival of the Goods at the consignee's end. In case of delay, the Supplier will be responsible for any consequent expenses.

11. Insurance

11.1. Wherever necessary, the goods supplied under the contract, shall be fully insured in a freely convertible currency against loss or damage incidental to manufacture or acquisition, transportation, delivery, storage and erection and commissioning at site (wherever applicable) in the manner specified in the contract. The insurance is to be done for coverage on "all risks" basis including war risks and strike clauses. The amount to be covered under insurance should be 110% of the invoice value to take care of the overall expenditure to be incurred by the purchaser for receiving the goods at the destination.

11.2. Where delivery of imported goods is required by the purchaser on CIF/CIP basis, the supplier shall arrange and pay for marine/air insurance, making the purchaser as the beneficiary. Where delivery is on FCA/ FOB/ CFR basis, marine/air insurance shall be the responsibility of the purchaser.

11.3. In case of domestic supplies on Free Delivery at site/FOR Destination basis, the supplier has to arrange insurance at its cost. For Ex-works and FOR station of dispatch contracts, it is the responsibility of the purchaser to arrange for insurance.

11.4. Where the delivery of the Goods is on CIP Basis, the supplier shall deliver the goods at the named place of destination at its own risks and costs. CIL has no obligation to the supplier for arranging insurance. However, CIL will provide the supplier upon request, with necessary information for obtaining insurance.

11.5. Where the delivery of the Goods is on FOR destination Basis, the supplier shall deliver the goods at the FOR destination site at its own risks and costs. CIL has no obligation to the supplier for arranging insurance. However, CIL will provide the supplier upon request, with necessary information for obtaining insurance".

12. Transportation

12.1. In case of FOB (Port of Shipment) contracts, the purchaser has to arrange transportation its own cost and risk.

12.2. In case of CIF (Port of Destination) contracts, transport of the goods to the port of destination in the Purchaser's country, as shall be specified in the contract, shall be arranged and paid for by the Supplier, and the cost thereof shall be included in the Contract Price. In case of inland transportation of goods, the same is to be done through registered common carriers only.

12.3. In case of CIP (Final Place of Destination) contracts, transport of the goods to the port of destination and further to the named place of Final Destination in the Purchaser's country, as shall be specified in the contract, shall be arranged and paid for by the Supplier, and the cost thereof shall be included in the Contract Price. In case of inland transportation of goods, the same is to be done through registered common carriers only.

12.4. In case of FOR Destination contracts, transport of goods to the Destination site shall be arranged and paid for by the supplier and the cost thereof shall be included in the contract price. Transportation of goods is to be done through registered common carriers only.

13. Warranty

13.1. The Supplier warrants that the Goods supplied under the Contract are new, unused, of the most recent or current models and that they incorporate all recent improvements in design and materials unless provided otherwise in the Contract. The Supplier further warrants that all Goods supplied under this Contract shall have no defect arising from design, materials or workmanship or from any act or omission of the Supplier that may develop under normal use of the supplied Goods in the conditions prevailing in the purchaser's country.

13.2. This warranty shall remain valid for twelve (12) months from the date of Commissioning of the equipment.

ds
pmp

ds
ptu

12/11/2020
[Signature]

13.3. The Purchaser shall promptly notify the Supplier in writing of any claims arising under this warranty. The Supplier shall, within thirty days, repair or replace the defective Goods or parts thereof, free of cost at the ultimate destination. The Supplier shall take over the replaced parts/Goods at the time of their replacement. No claim whatsoever shall lie on the Purchaser for the replaced parts/Goods thereafter.

13.4. If the Supplier, having been notified, fails to remedy the defect(s) within thirty days, the Purchaser may proceed to take such remedial action as may be necessary, at the Supplier's risk and expense and without prejudice to any other rights which the Purchaser may have against the Supplier under the Contract.

14. Payment

14.1. Specific payment terms may be stipulated in the NIT and the resultant contracts depending on the nature of goods to be procured, as per provisions contained in Chapter-22.

14.2. Payment for Indian Agency Commission

The payment of Indian Agency Commission, if any, involved, may be considered in case of necessity, subject to compliance of the Government of India guidelines issued from time to time. Agency commission, if any, shall be paid in equivalent Indian Rupees, after erection and commissioning of the equipment, wherever applicable, within twenty-one days of submission of bills along with following documents:

(A) Copy of foreign principal's invoice.

(B) Copy of bill of lading.

(C) Certificate from State Bank of India regarding Bill selling exchange rate ruling on the date of bill of lading (in case of bank holiday on date of bill of lading, Bill Selling exchange rate on next working day shall be considered).

(D) In case of procurement of equipment, commissioning certificate signed by the concerned officers of the Project and countersigned by the Area General Manager and HOD of Technical Dept, of the subsidiary company, where the equipment has been deployed.

14.3. In order to enable the purchaser to avail Input Tax Credit as per applicable Indian laws, the supplier shall furnish all the necessary documents to the consignee / paying authority as required, failing which the equivalent deduction will be made from the supplier's bills. In case of successful bidder(s), if at the time of supply, it is found that Input Tax Credit as per Invoice (Credit available to CIL / Subsidiary on this account) is less than the "Input Tax Credit Amount" declared in the Price Bid, the differential amount between the two shall be deducted from the Supplier's bills while making payment to them. If the evaluation of the supplier has been made considering the concessional rate of customs duty applicable for import from certain countries under trade agreements / treaties with Govt, of India, all the required documentation for availing concessional customs duty and subsequent customs clearance etc. will be provided by the supplier failing which the equivalent deduction will be made from their bills.

15. Changes in Order

The Purchaser may at any time, by a written order given to the Supplier, make changes within the general scope of the Contract in any one or more of the following:

a) drawings, designs or specifications, where Goods to be furnished under the Contract are to be specifically manufactured for the Purchaser;

b) the method of shipment or packing;

c) the place of delivery; and/or

d) the place of Services to be provided by the Supplier.

16. Contract Amendments

Subject to relevant clause of GCC, no variation in or modification of the terms of the Contract/ Purchase Order shall be made except by written amendment issued against the Contract/ Purchase Order.

17. Assignment

The Supplier shall not assign, in whole or in part, its obligations to perform under this Contract, except with the Purchaser's prior written consent. However, the consent of the Purchaser shall not relieve the supplier from any obligation, duty or responsibility under the contract.

18. Subcontracts

The Supplier shall notify the Purchaser in writing of all subcontracts awarded by it to discharge the works under this Contract. Such notification, in the original bid or later, shall not relieve the Supplier of any liability or obligation under the Contract and the supplier will be solely responsible for all obligations under the contract.

19. Delays in the Supplier's Performance

19.1. Delivery of the Goods and performance of Services shall be made by the Supplier in accordance with the time schedule prescribed by the Purchaser in the Schedule of Requirements.

19.2. If at any time during performance of the Contract, the Supplier or its Subcontractor(s) should encounter conditions impeding timely delivery of the Goods and performance of Services, the Supplier shall promptly notify the Purchaser in writing of the fact of the delay, its likely duration and its cause(s). As soon as practicable after receipt of the Supplier's notice, the Purchaser shall evaluate the situation and may at its discretion extend the Supplier's time for performance, with or without liquidated damages, by way of an amendment to the Contract/ Purchase Order.

19.3. Except as provided under Force Majeure clause, a delay by the Supplier in the performance of its delivery obligations shall render the Supplier liable to the imposition of liquidated damages, unless an extension of time is agreed upon pursuant to relevant clause without the application of liquidated damages.

20. Liquidated Damages

20.1. In the event of failure to deliver or dispatch the equipment/stores within the stipulated date/period in accordance with the terms and conditions and the specifications mentioned in the supply order and in the event of breach of any of the terms and conditions mentioned in the supply order, the Purchaser shall have the right:

(a) To recover from the successful bidder as agreed liquidated damages, a sum not less than 0.5% (Half Percent) of the price of any equipment/ stores which the successful tenderer has not been able to supply as aforesaid for each week or part of a week during which the delivery of such stores may be in arrears limited to 10% (Ten Percent) of the total contract value, or

(b) To purchase elsewhere after due notice to the successful tenderer on the account and at the risk of the defaulting supplier, the equipment/stores not supplied or others of similar description without cancelling the supply order in respect of the consignment not yet due for supply, or

(c) To cancel the supply order or a portion thereof, and if so desired to purchase the equipment/ stores at the risk and cost of the defaulting supplier and also,

(d) To extend the period of delivery with or without penalty as may be considered fit and proper. The penalty, if imposed, shall not be more than the agreed liquidated damages referred to in clause (a) above.

(e) To forfeit the security deposit fully or in part.

ds
12/11/20

ds
12/11

ds
12/11/20

(f) Whenever under this contract any sum of money is recoverable from and payable by the supplier, the Purchaser shall be entitled to recover such sum by appropriating in part or in whole by deducting any sum or which at any time thereafter may become due to the successful tenderer in this or any other contract. Should this sum be not sufficient to recover the full amount recoverable, the successful tenderer shall pay the Purchaser on demand the remaining balance. The supplier shall not be entitled to any gain on any such purchase.

20.2. For the purpose of the calculation of the liquidated damages amount, the basic FOR Destination price shall be considered. For direct imports, the CIP price at Final Place of destination will be considered. Taxes and duties shall not be taken into account for calculation of LD. However, when prices indicated in the order are inclusive of taxes and duties, such prices will be taken for calculation of LD.

21. Termination for Default and breach of contract

21.1. The Purchaser, without prejudice to any other remedy for breach of Contract, by written notice of default sent to the Supplier, may terminate the Contract in whole or in part:

- (a) If the supplier fails to deliver any or all of the stores within the time period(s) specified in the contract, or any extension thereof granted by the Purchaser; or
- (b) If the supplier fails to perform any other obligation under the contract within the period specified in the contract or any extension thereof granted by the purchaser; or
- (c) If the Supplier, in the judgement of the Purchaser, has engaged in corrupt or fraudulent practices in competing for or in executing the Contract.

21.2. For the purpose of this Clause:

- (i) "corrupt practice" means the offering, giving, receiving or soliciting of anything of value to influence the actions of a public official in the procurement process or in contract execution; and
- (ii) "fraudulent practice" means a misrepresentation of facts in order to influence a procurement process or the execution of a contract to the detriment of the Purchaser, and includes collusive practice among Bidders (prior to or after bid submission) designed to establish bid prices at artificial non-competitive levels and to deprive the Purchaser of the benefits of free and open competition.

21.3. In the event the Purchaser terminates the Contract in whole or in part, pursuant to relevant clause, the Purchaser may procure on such terms and in such manner as it deems appropriate, Goods or Services similar to those undelivered, and the Supplier shall be liable to the Purchaser for any excess costs for such similar Goods or Services. However, the Supplier shall continue performance of the Contract to the extent not terminated.

22. Force Majeure

22.1 Force Majeure means an event beyond the control of the supplier and not involving the supplier's fault or negligence and which is not foreseeable. Such events may include, but are not restricted to, acts of the purchaser either in its sovereign or contractual capacity, wars or revolutions, hostility, acts of public enemy, civil commotion, sabotage, fires, floods, explosions, epidemics, quarantine restrictions, strikes, lockouts, freight embargoes and act of God.

22.2 If there is delay in performance or other failures by the supplier to perform its obligation under the contract due to an event of a Force Majeure and the contract is governed by Force Majeure Clause, the supplier shall not be held responsible for such delays/failures.

22.3 In such a situation, the supplier shall promptly notify the purchaser in writing of such conditions and the cause thereof, duly certified by the local Chamber of Commerce or Statutory authorities, the beginning and end of the causes of the delay, within twenty one days of occurrence and cessation of such Force Majeure Conditions. Unless otherwise directed by the purchaser in writing, the supplier shall continue to perform its obligations under the contract as far as reasonably practical and shall seek all reasonable alternative means for performance not prevented by the Force Majeure event.

22.4 If the performance in whole or in part or any obligation under this contract is prevented or delayed by any reason of Force Majeure for a period exceeding sixty days, either party may at its option terminate the contract without any financial repercussion on either side.

22.5 For delays arising out of Force Majeure, the supplier will not claim extension in completion date for a period exceeding the period of delay attributable to the causes of Force Majeure.

22.6 There may be a Force Majeure situation affecting the purchaser also. In such a situation, the purchaser is to take up with the supplier on similar lines as above for further necessary action.

22.7 The contract shall be governed by the following Force Majeure Clause:

"If at any time, during the continuance of this contract, the performance in whole or in part by either party of any obligation under this contract shall be prevented or delayed by reason of any wars or revolutions, hostility, acts of public enemy, civil commotion, sabotage, fires, floods, explosions, epidemics, quarantine restrictions, strikes, lockouts, freight embargoes or act of God (hereinafter referred to "events ") provided, notice of the happening of any such event is given by either party to the other within 21 days from the date of occurrence thereof, neither party shall by reason of such event, be entitled to terminate this contract nor shall either party have any claim for damages against the other in respect of such non-performance or delay in performance, and deliveries under the contract shall be resumed as soon as practicable after such event has come to an end or ceased to exist, PROVIDED FURTHER that if the performance in whole or part or any obligation under this contract is prevented or delayed by reason of any such event for a period exceeding 60 days, either party may at its option terminate the contract provided also that if the contract is terminated under this clause, the purchaser shall be at liberty to take over from the contractor at a price to be fixed by the CIL/Subsidiary Company, which shall be final, all unused, undamaged and acceptable materials, bought out components and stores in course of manufacture in the possession of the contractor at the time of such termination or such portion thereof as the purchaser may deem fit excepting such materials, bought out components and stores as the contractor may with the concurrence of the purchaser elect to retain."

23. Termination for Insolvency

The Purchaser may at any time terminate the Contract by giving written notice to the Supplier if the Supplier becomes bankrupt or otherwise insolvent. In this event, termination will be without compensation to the Supplier, provided that such termination will not prejudice or affect any right of action or remedy which has accrued or will accrue thereafter to the Purchaser.

24. Termination for Convenience

24.1 The Purchaser, by written notice sent to the Supplier, may terminate the Contract, in whole or in part, at any time for its convenience. The notice of termination shall specify that termination is for the Purchaser's convenience, the extent to which performance of the Supplier under the Contract is terminated, and the date upon which such termination becomes effective.

24.2 The Goods that are complete and ready for shipment within thirty (30) days after the Supplier's receipt of notice of termination shall be accepted by the Purchaser at the Contract terms and prices. For the remaining Goods, the Purchaser may elect:

- a) to have any portion completed and delivered at the Contract terms and prices; and/or

Handwritten signatures and initials: dhr, p/11/20

Handwritten signature and date: 12/11/2020

b) to cancel the remainder and pay to the Supplier an agreed amount for partially completed Goods and Services and for materials and parts previously procured by the Supplier.

25. Governing Language

The Contract shall be written in English language. All correspondence and other documents pertaining to the Contract which are exchanged by the Parties shall be written in the same language.

26. Taxes and Duties

26.1 A foreign Supplier shall be entirely responsible for all taxes, duties, license fees and other such levies imposed outside the Purchaser's country. The foreign supplier shall also be responsible for all taxes & duties in Purchaser's country legally applicable during execution of the contract other than those which are to be paid by purchaser, as specified in as per relevant clause of NIT.

26.2 A Domestic Supplier shall be entirely responsible for all taxes, duties, licence fees etc., incurred until the execution of the contract, other than those which are to be paid by purchaser, as specified in as per relevant clause of NIT.

27. Limitation of Liabilities

27.1 Notwithstanding anything herein to the contrary, no party shall be liable for any indirect, special, punitive, consequential or exemplary damages, whether foreseeable or not, arising out of or in relation to this contract, loss of goodwill or profits, lost business however characterised, any/ or from any other remote cause whatsoever.

27.2 The supplier shall not be liable to the purchaser for any losses, claims, damages, costs or expenses whatsoever arising out of or in connection with this contract in excess of the contract value of the equipment supplied hereunder which caused such losses, claims, damages, costs or expenses.

27.3 However, the limitation of liability of the supplier indicated above shall not apply to Liquidated damages.

28. Settlement of commercial disputes in case of contracts with Public Sector Enterprises/ Govt. Dept.(s)

28.1 In the event of any dispute or difference relating to the interpretation and application of the provisions of commercial contract(s) between CPSEs and Government Departments/ Organizations (excluding disputes concerning Railways, Income Tax, Customs & Excise Departments), such dispute or difference shall be taken up by either party for its resolution through Administrative Mechanism for Resolution of CPSEs Disputes (AMRCD), as per the guidelines stipulated in the Office Memorandum No. 4(1)/2013- DPE(GM)/FTS-1835 dated 22.05.2018 of Department of Public Enterprises, Ministry of Heavy Industries and Public Enterprises, Govt, of India.

28.2 In case of contract with a Public Sector Enterprise or Govt. Dept., the following Arbitration Clause shall be incorporated in the contract:-

"In the event of any dispute or difference relating to the interpretation and application of the provisions of commercial contracts between Central Public Sector Enterprises (CPSEs)/ Port Trusts inter se and also between CPSEs and Government Departments/ Organizations (excluding disputes concerning Railways, Income Tax, Customs & Excise Departments), such dispute or difference shall be taken up by either party for resolution through AMRCD as mentioned in DPE OM No. 4(1)/2013-DPE(GM)/FTS- 1835 dated 22.05.2018."

29. Progress Reports

29.1 The Supplier shall from time to time render such reports concerning the progress of the contract and/or supply of the stores in such form as may be required by the Purchaser.

29.2 The submission, receipt and acceptance of such reports shall not prejudice the right of the Purchaser under the contract nor shall operate as an estoppel against the Purchaser merely by reason of the fact that he has not taken notice of or objected to any information contained in such report.

30. Provisions of CIL's Purchase Manual

The provisions of CIL's Purchase Manual and its subsequent amendments (Available on CIL's website, www.coalindia.in) shall also be applicable, if not specified otherwise in this Bid document.

31. Applicable Law

The Contract shall be governed by the laws of the Republic of India, unless otherwise specified in the bid document.

32. Jurisdiction of Courts

32.1 Irrespective of the place of delivery, the place of performance or place of payment under the contract, the contract shall be deemed to have been made at the place from where the acceptance of tender or supply order has been issued.

32.2 The courts of the place from where the acceptance of tender has been issued shall alone have jurisdiction to decide any dispute arising out of or in respect of the contract.

33. Notices

33.1 Any notice given by one Party to the other pursuant to this Contract shall be sent to the other Party in writing or facsimile to be confirmed in writing, to the other Party's address. For the purpose of all notices, the following shall be the addresses of the Purchaser and the Supplier (as indicated in the Contract / Order)

33.2 A notice shall be effective when delivered or on the notice's effective date, whichever is later.

33.3 In case of change in address, the Supplier shall immediately notify the same to the Purchaser in writing. The supplier shall be solely responsible for the consequences of omission to notify the change of address to the Purchaser.

ds
12/11/20

ds
12/11/20

[Signature]
12/11/2020

ANNEXURE -IV

FORMAT FOR SECURITY CUM PERFORMANCE BANK GUARANTEE

1. In consideration of M/s. Western Coalfields Limited, Nagpur (hereinafter called "The Company") having agreed to exempt _____ (hereinafter called "The said Contractor(s)") from the demand, under the terms and conditions of the agreement dated _____ made between _____ and _____ for _____ (hereinafter called " the said Agreement"), of security deposit for the due fulfillment by the said contractor(s) of the terms and conditions contained in said Agreement, on production of bank guarantee for Rs. _____ (Rupees _____ only).
We _____ (indicate the name of bank) (hereinafter referred to as "the Bank") at the request of _____ (Contractor(s) do hereby undertake to pay to the Company an amount not exceeding Rs. _____ against any loss or damage caused to or suffered or would be caused to or suffered by the Company by reasons of any breach by the said Contractor(s) of any terms or conditions contained in the said Agreement.
2. We _____ do hereby undertake (indicate the name of the Bank) to pay the amounts due and payable under this guarantee without any demur, merely on demand from the Company stating that the amount claimed is due by way of loss or damage caused to or would be caused to or suffered by the Company by reason of breach by the said contractor(s) of any of the terms or conditions contained in the said agreement or by reason of the contractor(s)'s failure to perform the said agreement. Any such demand made on the bank shall be conclusive as regards the amount due and payable by the bank under this guarantee. However, our liability under this guarantee shall be restricted to an amount not exceeding Rs. _____ only.
3. We undertake to pay to the Company any money so demanded notwithstanding any dispute or disputes raised by the contractor(s) supplier(s) in any suit or proceeding pending before any court or tribunal relating thereto our liability under this present being absolute and unequivocal :
The payment so made by under this bond shall be a valid discharge of our liability for payment there under and the contractor(s)/supplier(s) shall have no claim against us _____ for making such payment.
4. We _____ further agree that the _____ (indicate the name of the Bank) guarantee herein contained shall remain in full force and affect during the period that would be taken for performance of the said Agreement and that it shall continue to be enforceable till all the dues of the company under or by virtue of the said Agreement have been fully paid and its claims satisfied or discharged or till the company certified that the said agreement have been fully and properly carried out by the said contractor(s) and accordingly discharges this guarantee. The guarantee shall remain in force till the _____ the day of _____ 20 _____ and unless a demand or claim under the guarantee is made on us in writing within 3 months from the said date, shall be discharged from all liabilities under this guarantee thereafter.
5. We _____ further agree with the _____ (indicate the name of the Bank) Company that the company shall have fullest liberty without our consent and without affecting in any manner our obligations, hereunder to vary any of the terms and conditions of the said agreement or to extend time of performance by the said contractor(s) from time to time or to postpone for any time or from time to time any of the powers exercisable by the company against the said contractor(s) and to for bear or enforce any of the terms and conditions relating to the said agreement and we shall not be relieved from our liability by reasons of any such variation, or extension being granted to the said contractor(s) or for any forbearance, act or commission on part of the company or any indulgence by the company to the said contractor(s) or by any such matter or thing whatsoever which under the law relating to sureties would, but for this provision, have effect of so relieving us.
6. This guarantee will not be discharged due to the change in constitution of the bank or the contractor(s)/supplier(s).
7. We _____ lastly undertake not to revoke this _____ (indicate the name of the Bank) guarantee during its currency except with the previous consent of the company in writing.

The Bank Guarantee is operational for all purposes at Nagpur Branch, Maharashtra (Branch code -----)

Dated the _____ day of _____ 20 _____

Signature of the authorised person
for and on behalf of the Bank.

For _____

(indicate the name of the Bank)

Handwritten signatures and date: 12/11

Handwritten signature and date: 12/11/2020

PONo: 11100132420165

Dated: 12.11.2020

Procedure for submission of Bank Guarantee in SFMS platform

The Bank Guarantee issued by the issuing bank on behalf of the supplier in the favour of Western Coalfields Ltd shall be in paper form as well as issued under "Structured financial messaging system". The details of beneficiary for issue of BG under SFMS platform is furnished below:

Name of beneficiary and details

Name	Western Coalfields Ltd
Area	Head Quarter
Bank A/c No: / Cust ID of beneficiary	Current Account no: 005905018053; Customer Id: 556096497 ; ICICI Bank Ltd, Commercial Banking, 9C/A& 9C/B, Ground Floor, Shriram Towers, LIC Square, Nagpur – 440001, Maharashtra
IFSC code	ICIC0000059
Bank Manager Name & Ph no:	UJJWAL KITE: Ph n: 0712-6627389
BG ADVISING MESSAGE – 760COV / 767COV via SFMS	
Field Number	Particulars
7035	ICICI0000059
7037	WCL556096497

The original bank guarantee issued by the issuing bank shall be sent by the issuing bank to the following address by Registered post /AD.

General Manager (MM) I/c
Materials Management Wing
Western coalfields Ltd HQ
Coal Estate, Civil lines, Nagpur – 440001
Maharashtra

Any extension / amendments to the BG shall be done following the same procedure as above.

Handwritten signature and date: 12/11/20

Handwritten signature and date: 12/11/2020

ANNEXURE-V

AREA	Allocated quantity in Nos	BC GIVEN	BC REFERENCE NO.
PATHAKHERA	96	262080	WCL/PKD/20-21/OTHER STORE/E&M/HQ/DT.09.10.20 FOR Rs 262080
PENCH	72	196560	R/1/19/20-21/DT.12.10.2020 for Rs196560
NAGPUR	48	131040	AFM/CGM/NG/BC/REV/AB CLASS/20-21/P-51/233 DT.12.10.2020 .BC forRs 131040/e&m/os
UMRER	05	13650	UA/HQ/OTHER STORE /AB CLASS/02/18/BC/20-21/DTD.20.09.19
WANI NORTH	05	13650	REV/WNA/HQ-A&B/20-21/E&M/7 DT.05.11.2020
CHANDRAPUR	168	458640	RB/CHA/AREA/MB/A&B- E&M OTHER STORES/89/20/20-21/ FOR Rs 458640 dt.30.10.2020
BALLARPUR	86	234780	BA/RB/35/169/20-21/HQ/CP/CP/COAL TUB WHEEL /DT.24.10.20 FOR Rs 234780
Total	480	1310400	

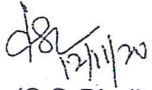
(S S Bhal)
Chief Manager(MM)



(K S R Divakar)
Chief Manager (MM)

